

PFA Lined Magnetic Drive Centrifugal Pumps

Efficient – Non-Corroding – Vacuum-Resistant

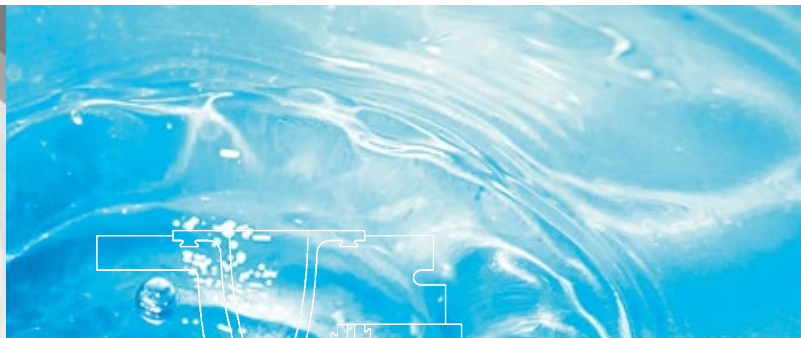

MKPL

Magnetic drive chemical process pump

MKPL-S

Self-priming magnetic drive chemical process pump

Designed to:

DIN EN ISO 2858, 5199 and 15783

Compliant with:

EC Machinery Directive

EC ATEX Directive

FDA 21 CFR §177

With SI and US range curves

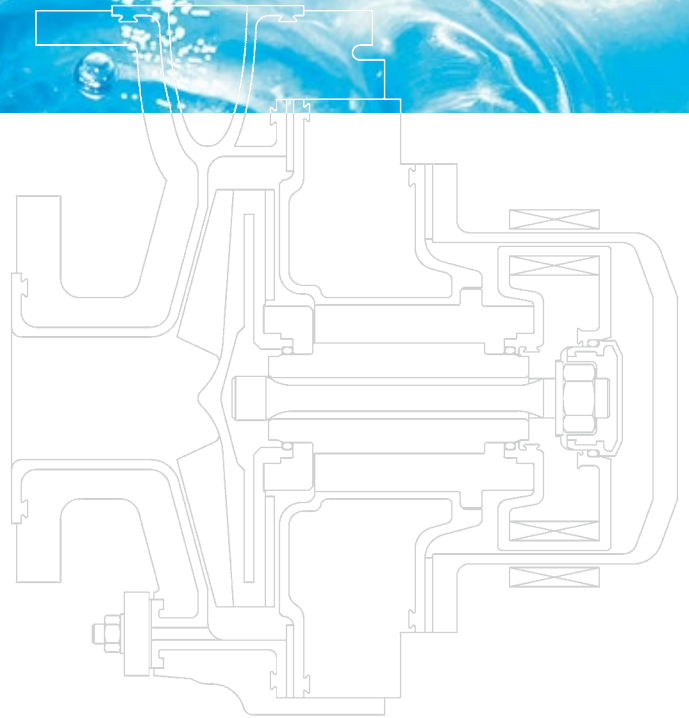



Open impeller of PFA lined magnetic drive pumps



CP Pump Systems

PFA Lined Magnetic Drive Centrifugal Pumps

Our company

CP is a highly innovative Swiss company with a rich tradition. Since 1948 we have specialised in developing and manufacturing premium quality high-tech products and providing services for international customers with the most rigorous requirements.

We produce reliable and innovative centrifugal pumps for the chemical, pharmaceutical, petrochemical, biotechnology, food and beverage industries. CP is represented in over 70 countries through its network and offers first-class customer services. This proximity guarantees customers worldwide an efficient local service.

Reflecting our deep commitment to energy efficient products and services, we deliver environmentally friendly solutions that always go hand in hand with maximum safety and economy. As a pioneer in this area, we advise and assist customers with a wide range of needs – throughout the value chain.

CP operates a quality management system certified to ISO 9001.

Energy efficiency in industry

Nowadays, industry is facing increasing demands to improve sustainability and energy efficiency. Pumps are considered to play a key role because they offer vast potential to save energy and costs. Already recognising this back in 1999, CP took action and has become a pioneer in energy-saving pumping systems.

In recent years, we have continuously enhanced the hydraulic performance of numerous pump systems, increasing their efficiency by up to 30 per cent. At the same time, we have steadily improved pump safety, a mission we have vigorously pursued ever since our company was established in 1948.

We are wholeheartedly committed to promoting sustainable manufacturing in industry around the world. Our customers benefit from a comprehensive range of solutions that reduce costs and CO₂ emissions over the long term. Cleaner pumps, cleaner planet: we firmly believe that sustainable research, thinking and action always pay off for everyone.

PFA lined magnetic drive centrifugal pumps

With their sealless design, the MKPL and MKPL-S magnetic drive pumps are ideal to meet the stringent requirements of chemical processing and a multitude of other industries. These highly advanced and extremely energy efficient pumps are built to handle a huge variety of corrosive fluids reliably and absolutely safely, especially even in high temperature applications.

The pump casing has a thick, heavy-duty, corrosion- and permeation-resistant PFA lining, mechanically locked into the metal armour, ensuring vacuum resistance. This armour absorbs mechanical stresses that can result from system pressure or piping nozzle loads.

Made of pure SSiC (sintered silicon carbide) in a robust design engineered for ceramics, the bearing assembly provides maximum reliability of pump operation. Plain and thrust bearings are secured with polygonal form-fit, self-centring anti-rotation devices.

The MKPL and MKPL-S pumps come with either an open impeller or a closed impeller. The impellers consist of a metallic core for mechanical strength and a thick PFA lining which is firmly connected with the core.

Both pumps are constructed with just a few, robust components using an intelligent modular system that facilitates assembly and minimises the costs of spare parts, maintenance and servicing.

MKPL

PFA Lined Magnetic Drive Chemical Process Pump

Designed for operating at up to +200°C, the MKPL pump is built for safety in handling corrosive fluids in high temperature applications. Its connection dimensions and performance data conform to DIN EN ISO 2858, making the MKPL easy to retrofit into any installation to replace old pumps.

Technical data

Capacities (min./max.)	0.5 to 350 m ³ /h
Heads (min./max.)	3 to 80 m
Temperatures (min./max.)	-20 to +200°C
Kinematic viscosities	0.5 to 350 mm ² /s
Solids handling	up to 10% solids concentration, depending on the pumped fluid*

Directives

EC Machinery Directive
EC ATEX Directive
FDA 21 CFR §177

Standards

DIN EN ISO 2858
DIN EN ISO 5199
DIN EN ISO 15783

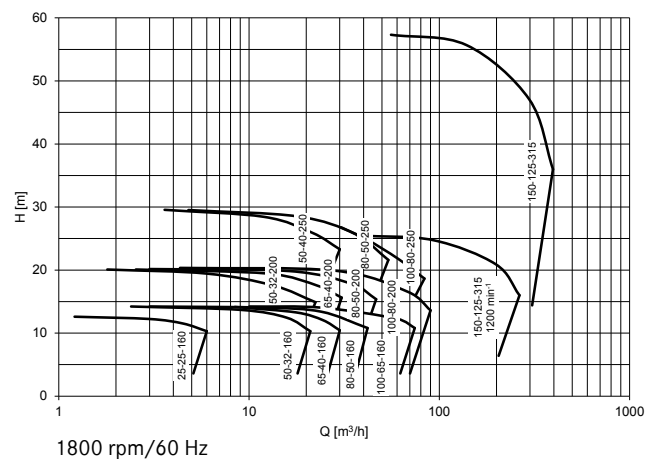
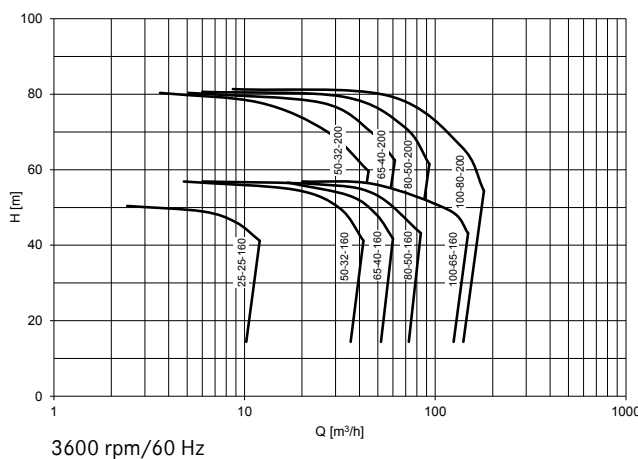
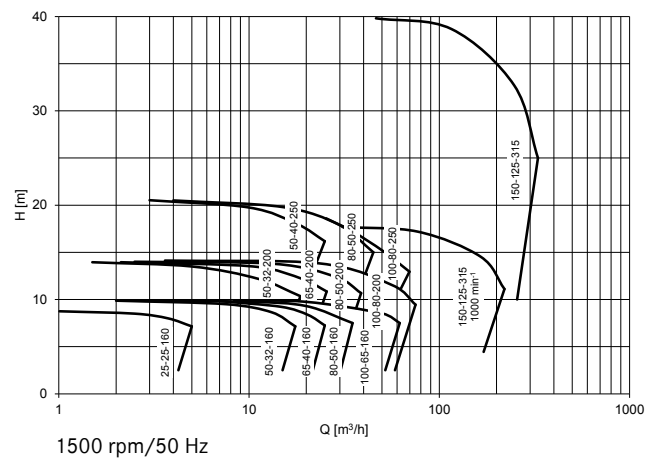
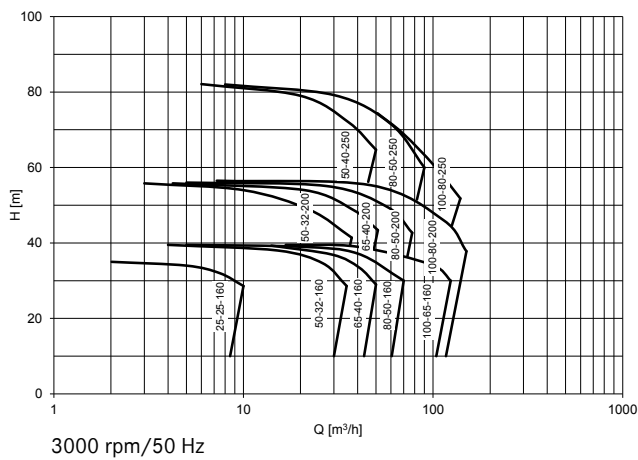



MKPL

PFA Lined Magnetic Drive Chemical Process Pump

Designed for operating at up to +392°F, the MKPL pump is built for safety in handling corrosive fluids in high temperature applications. Its connection dimensions and performance data conform to DIN EN ISO 2858, making the MKPL easy to retrofit into any installation to replace old pumps.

Technical data	
Capacities (min./max.)	2.2 to 1761.2 gpm
Heads (min./max.)	9.8 to 295.2 ft
Temperatures (min./max.)	-4 to +392°F
Kinematic viscosities	0.5 to 350 cSt
Solids handling	up to 10% solids concentration, depending on the pumped fluid*

Directives
EC Machinery Directive
EC ATEX Directive
FDA 21 CFR §177

Standards
DIN EN ISO 2858
DIN EN ISO 5199
DIN EN ISO 15783

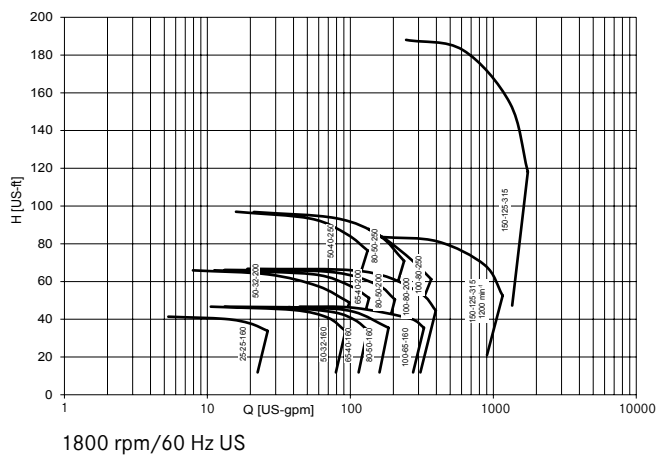
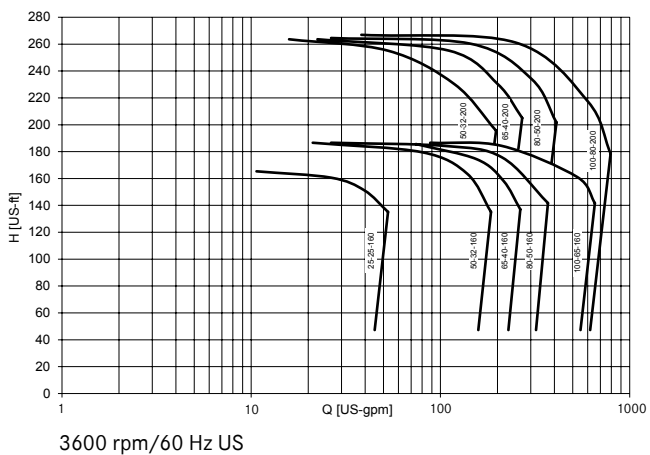

*In general, media with solids content can be transported, but application-specific verification in advance is necessary.

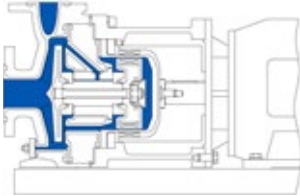

Close-coupled MKPL
with baseplate
-20 to +200°C

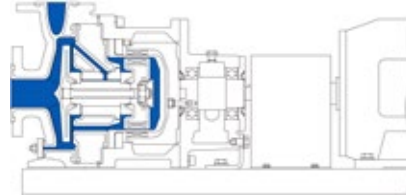

Bearing frame-mounted MKPL
with baseplate
-20 to +200°C



MKPL with baseplate and motor
horizontal close-coupled (-20 to +200°C)



MKPL-S

PFA Lined Self-Priming Magnetic Drive Chemical Process Pump

The MKPL-S features an integral priming chamber in the casing. A separate priming tank is not necessary because the pump evacuates the suction line itself by creating a vacuum. The MKPL-S can even readily pump entrained air in the suction line while running, thus increasing reliability of operation. This pump achieves suction lifts up to 40 m.

Technical data

Capacities (min./max.)	0.5 to 35 m ³ /h
Heads (min./max.)	3 to 40 m
Temperatures (min./max.)	-20 to +150°C
Kinematic viscosities	0.5 to 350 mm ² /s
Solids handling	up to 10% solids concentration, depending on the pumped fluid*

Directives

EC Machinery Directive
EC ATEX Directive

Standards

DIN EN ISO 5199
DIN EN ISO 15783

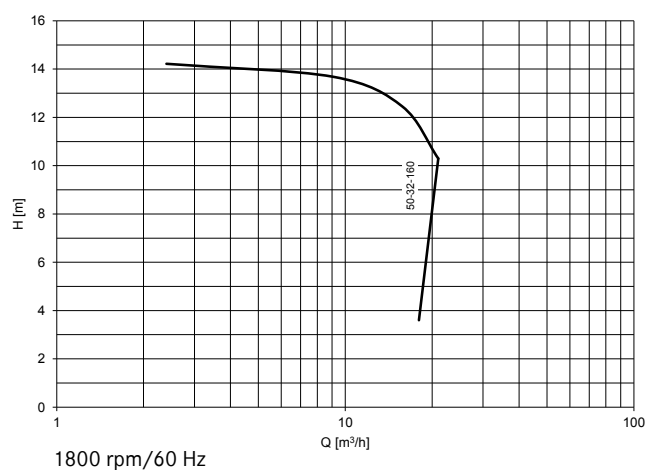
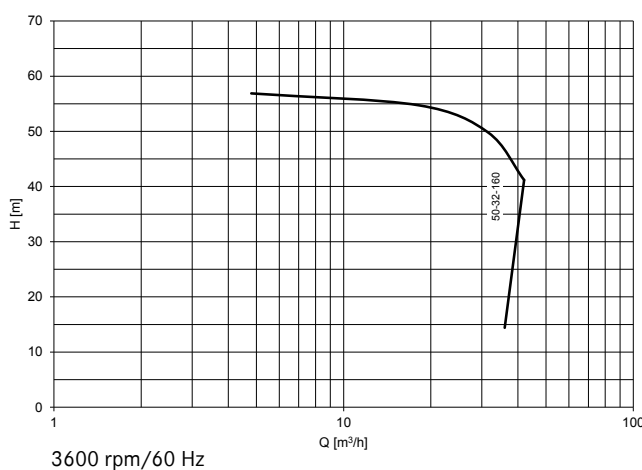
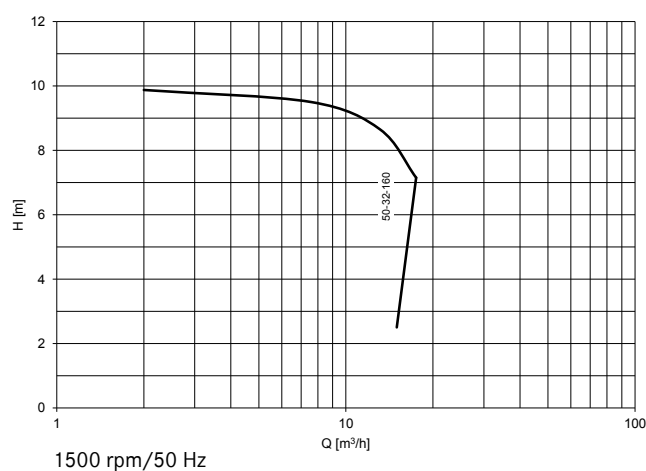
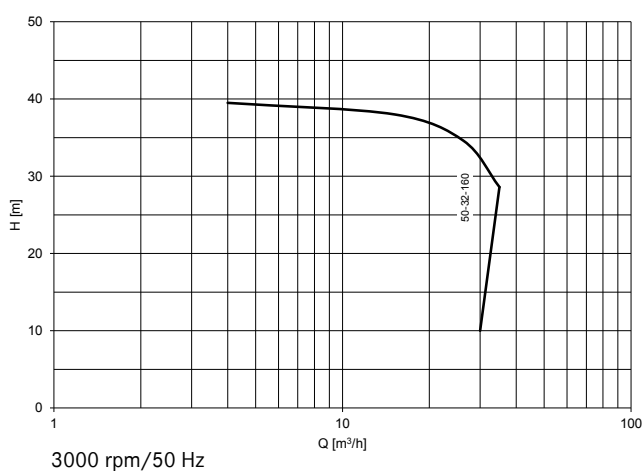

*In general, media with solids content can be transported, but application-specific verification in advance is necessary.



MKPL-S

PFA Lined Self-Priming Magnetic Drive Chemical Process Pump

The MKPL-S features an integral priming chamber in the casing. A separate priming tank is not necessary because the pump evacuates the suction line itself by creating a vacuum. The MKPL-S can even readily pump entrained air in the suction line while running, thus increasing reliability of operation. This pump achieves suction lifts up to 131.2 ft.

Technical data	
Capacities (min./max.)	2.2 to 154.1 gpm
Heads (min./max.)	9.8 to 131.2 ft
Temperatures (min./max.)	-4 to +302°F
Kinematic viscosities	0.5 to 350 cSt
Solids handling	up to 10% solids concentration, depending on the pumped fluid*

Directives
EC Machinery Directive
EC ATEX Directive

Standards
DIN EN ISO 5199
DIN EN ISO 15783

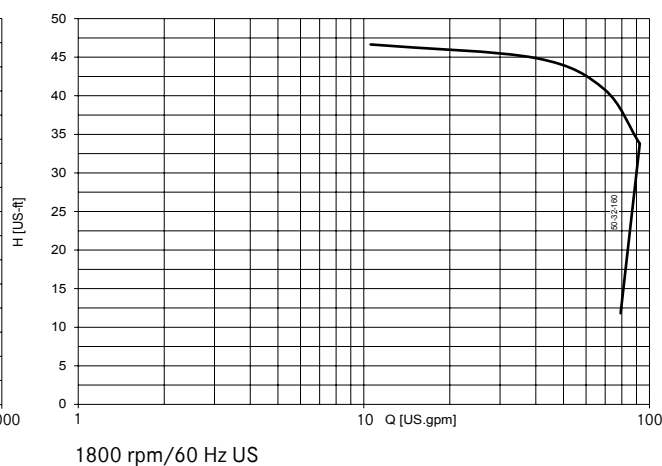
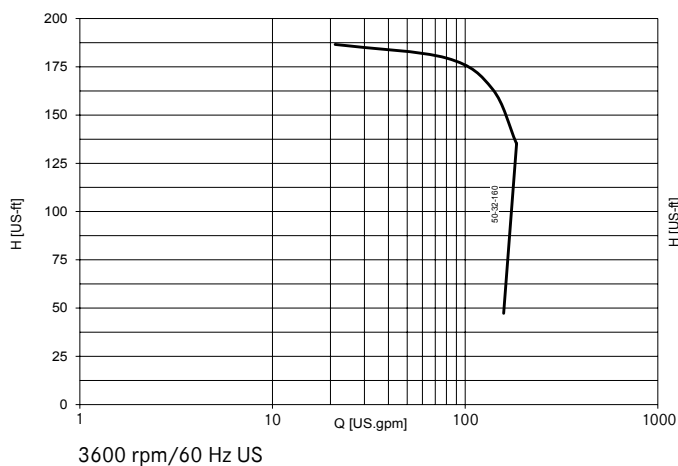

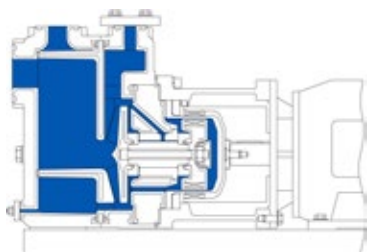

Close-coupled MKPL-S
with baseplate
-20 to +150°C

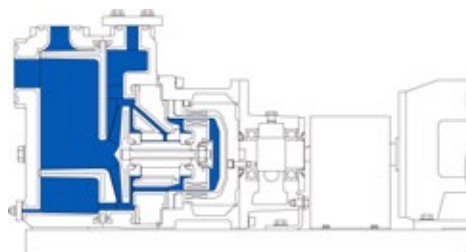

Frame-mounted MKPL-S
with baseplate
-20 to +150°C

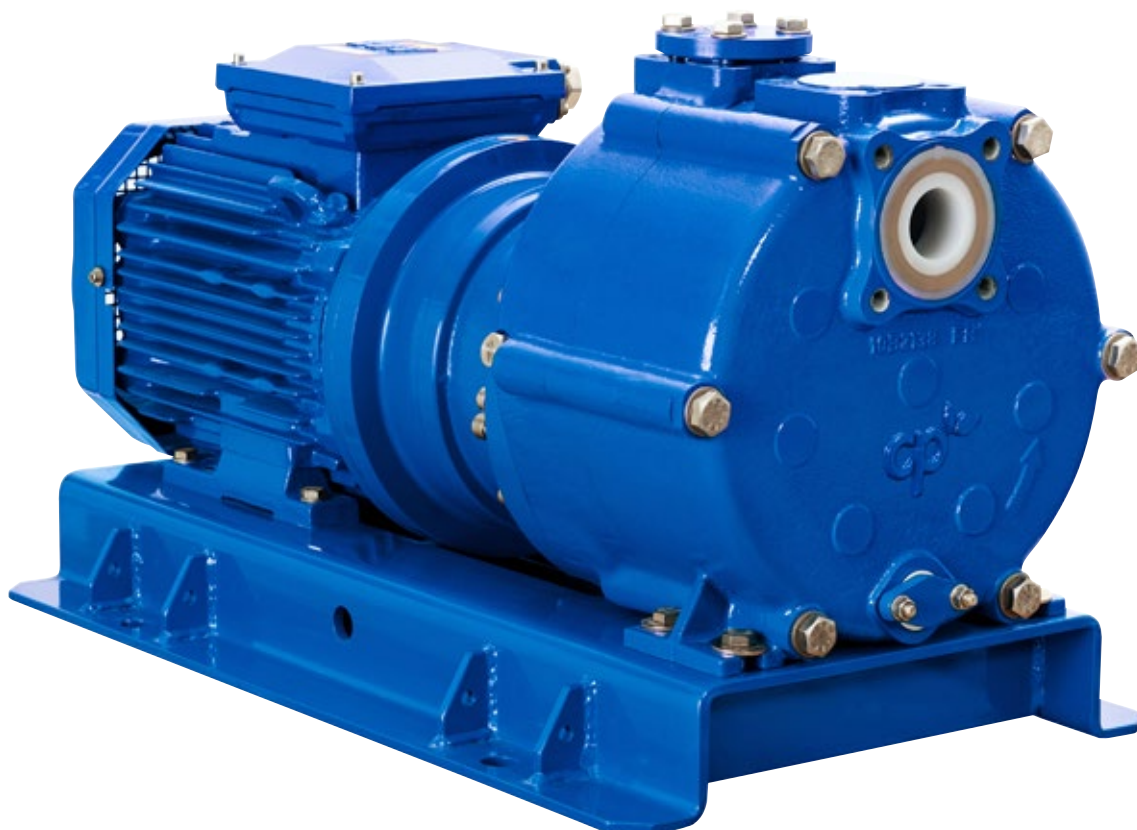

MKPL-S with baseplate and motor
horizontal close-coupled (-20 to +150°C)

Applications

Versatile – Complex – Special

CP's PFA lined magnetic drive pumps are engineered to meet the most stringent quality standards and ensure reliability and utmost safety in production operations. Suitable for many different fluids in a variety of industries and processes, they are capable of handling low, medium and high flow volumes. PFA lined magnetic drive pumps from CP offer tremendous advantages, especially in pumping sensitive or hazardous substances.

Industries

- Chemical processing: basic and fine chemicals (agrochemicals, speciality chemicals)
- Pharmaceuticals
- Biotechnology processing

Processes

CP's PFA lined magnetic drive pumps are designed for a wide range of processes, including:

- Chlor-alkali electrolysis
- Sulphuric acid recycling
- Tank unloading

Fluids

CP's PFA lined magnetic drive pumps can handle hot and/or highly concentrated acids, alkalis (bases), solvents and diffusing fluids.

For example:

- Bromine
- Chlorine
- Nitric acid
- Phosgene
- Potassium hydroxide solution
- Sodium hydroxide solution
- Sulphuric acid

Our sales staff will be glad to give you personalised advice tailored to your specific needs, industry, processes and fluids.



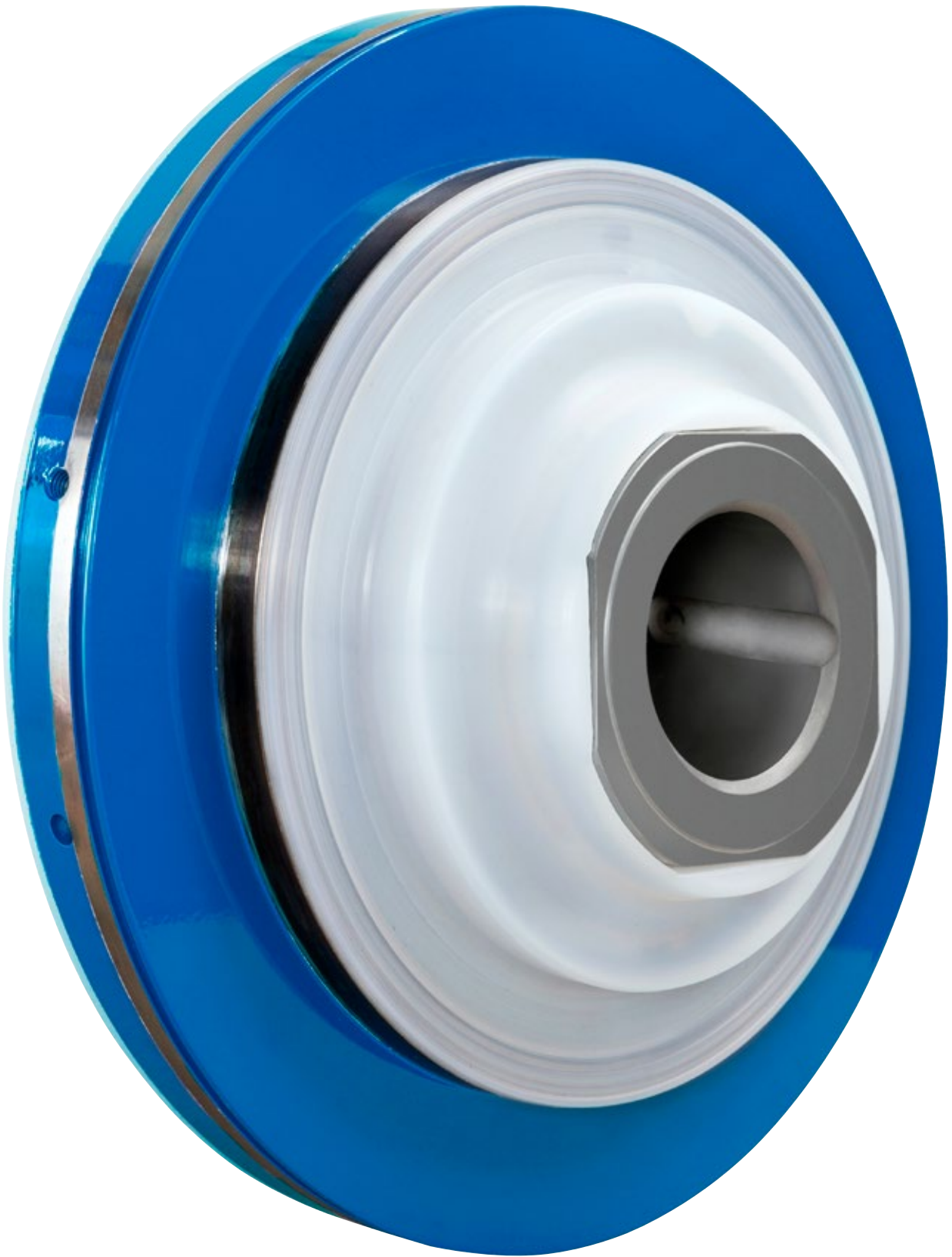

PFA lined metal plain bearing carrier

Options

Comprehensive – Individual – Combinable

Casing

Materials

- Cast iron (GGG 40.3)/vacuum-tight PFA lining

Pressure rating

- PN 16

Connection flanges

- To EN 1092-2
- Drilled to ANSI/ASME B16.5

Additional connections

- Casing drain (with or without flange)
- External flush connection for bearing lubrication and/or flushing and cooling the magnet assembly (for type MKPL)
- Lantern monitoring connection

Gasket materials

- PTFE
- PTFE/graphite

O-ring materials

- FEP/FKM
- Kalrez®/Chemraz®



Bearing assembly

Materials

- SSiC (sintered silicon carbide)
- SSiC with diamond-like coating (ADLC)
- SSiC with FuturaSafe®



Containment shell

With containment shell monitoring

Materials

- Carbon fibre reinforced PTFE
- Heat-resistant carbon fibre reinforced PTFE
- Carbon fibre reinforced PVDF





Pump protection

Containment shell leakage monitoring

Pt100 temperature probe

Engine load sensor



Mounts

Type

- Baseplate
- Horizontal

Materials

- Steel
- Stainless steel

Stilts

Drip pan

Grounding lugs



Bearing frame

Lubrication

- Oil lubrication
- Grease lubrication

Oil lubrication options

- Hermetic seal (MagTecta OM™)
- Constant level oiler

Coupling

Coupling guard

- Steel
- Brass



The options vary depending on the pump model. Our sales staff will be glad to advise you in detail.

Sectional View

MKPL

Bearing frame (-20 to +200°C), horizontal

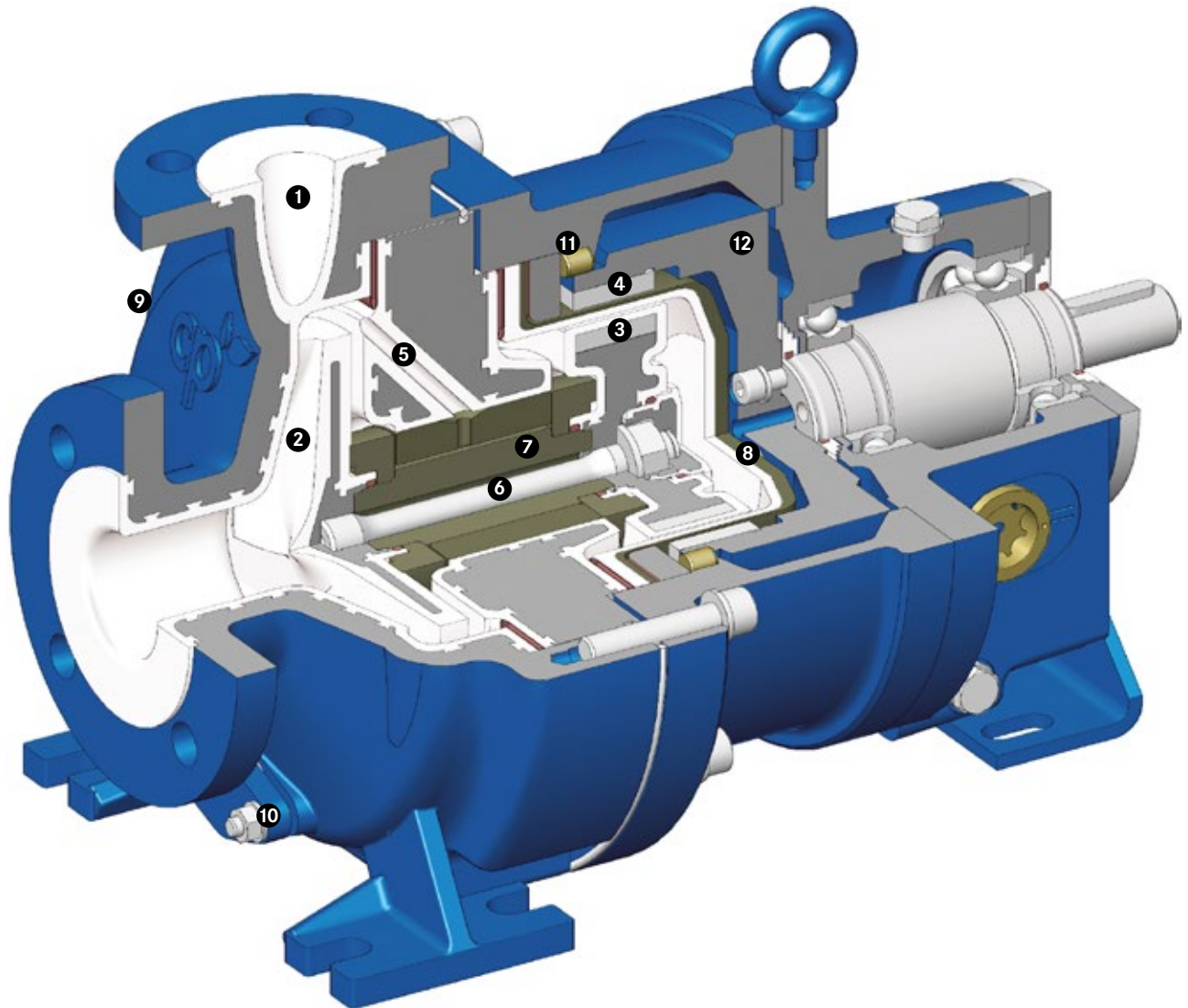

- | | |
|--|---|
| 1 Pump casing with PFA lining | 8 One-piece, vacuum-resistant, non-metallic containment shell |
| 2 Impeller | 9 Pt100 temperature probe on casing |
| 3 Inner magnet assembly (on product side) | 10 Casing drain |
| 4 Outer magnet assembly (on atmospheric side) | 11 Bump pin |
| 5 Internal bearing lubrication or external flush connection | 12 Flywheel |
| 6 Single bolt with waisted shank to fasten the rotating unit | |
| 7 Plain bearing assembly | |



CP Pump Systems

Our Product Portfolio

Customer service

We offer the highest quality, many years of experience and first-class advice from a single source. Our bespoke pump systems meet a wide range of different requirements.

CP's customers benefit from a full service offering: the fastest availability of genuine spare parts, a complete set of technical documentation, competent and efficient customer support, and a dynamic and flexible repair service. All these services ensure that your pumps will operate faultlessly. Thanks to a network in over 70 countries, we advise and serve our customers directly on site.

Energy efficiency consulting

As a trend scout specialised in energy efficiency, CP can deliver a wide spectrum of services relating to pumps and motors: comprehensive advice, in-depth system analysis, meticulous planning and design. Our goal is to actively help our customers optimise the energy consumption of their pumping systems and thereby cut costs over the long term.

Backed by our many years of broad experience, we today advise and assist customers in both the private and public sectors. These include owners and operators of fluid processing plants in the chemical, pharmaceutical and diverse other industries.

Are you interested? Do you have any questions? We would be happy to discuss all the different options with you personally.

Stainless steel magnetic drive centrifugal pumps

- MKP**
Magnetic drive chemical process pump

- MKP-S**
Self-priming magnetic drive chemical process pump

- MKTP**
Magnetic drive chemical process sump pump

- MKP-ANSI**
Magnetic drive chemical process pump

- MKPP**
Magnetic drive in-line chemical process peripheral pump

- SZMK**
Magnetic drive in-line chemical process pump

- Mobile centrifugal pump**
Mobile magnetic drive chemical process pump

Stainless steel magnetic drive biotech process pump

- MKP-Bio**
Magnetic drive centrifugal pump for sterile processes

PFA lined magnetic drive centrifugal pumps

- MKPL**
Magnetic drive chemical process pump

- MKPL-S**
Self-priming magnetic drive chemical process pump

Solid PTFE magnetic drive centrifugal pumps

- MSKP**
Magnetic drive chemical process pump

- MSKPP**
Magnetic drive chemical process peripheral pump

- MSKS**
Self-priming magnetic drive chemical process side channel pump

Stainless steel mechanical seal centrifugal pumps

- ZMP**
The 3-In-One mechanical seal chemical process pump: crushing, mixing and pumping

PFA lined double mechanical seal centrifugal pump

- EB**
Double mechanical seal chemical process pump

Ceramic lined double mechanical seal centrifugal pump

- ET**
Double mechanical seal chemical process pump



Improving energy efficiency in pumping systems helps to create a cleaner planet.

CP Pumpen AG 
Switzerland, Zofingen

CP Pumpen GmbH
Germany, Mannheim

CP Pumpen SAS
France, Strasbourg

CP Pumps Inc.
USA, Birmingham (AL)

Representative Office of CP Pumpen AG
Thailand, Bangkok

Please find your local CP distributor on
www.cp-pumps.com

or contact CP directly:
+41627468585 / info@cp-pumps.com.

