

Magnetic Drive Centrifugal Pump for Sterile Processes

Efficient – Hygienic – EHEDG-Compliant



MKP-Bio

Stainless steel magnetic drive biotech process pump

EHEDG-compliant

Designed to:
DIN EN 12462, DIN EN ISO 5199 and 15783

Compliant with:
EC Machinery Directive
EC ATEX Directive

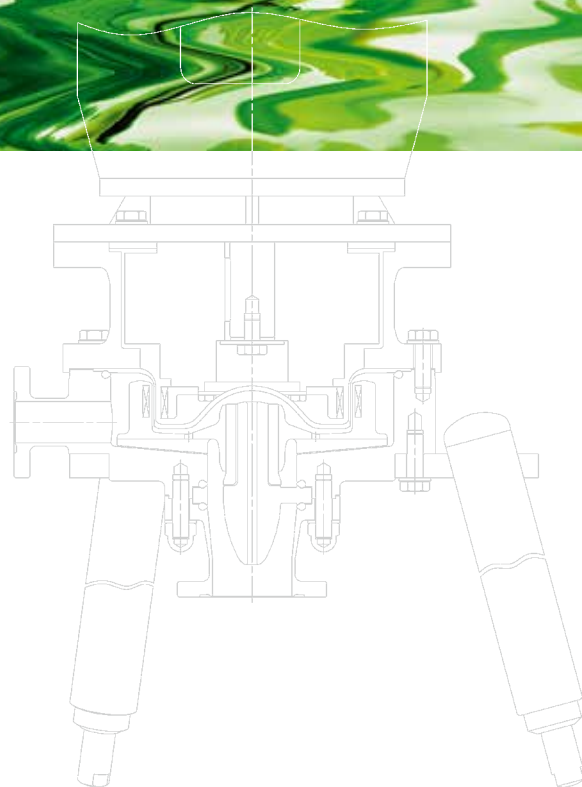

EHEDG Cleanability Test
for a Centrifugal Pump with Magnetic Drive
Test: No. 10/11.98 CP Pumpen AG, Zofingen, Switzerland
Lehrstuhl für Verfahrenstechnik disperser Systeme (VDS)

EHEDG Sterilisability Test
for a Centrifugal Pump with Magnetic Drive
Test: No. 10/11.98 CP Pumpen AG, Zofingen, Switzerland
Lehrstuhl für Verfahrenstechnik disperser Systeme (VDS)



Open impeller of the stainless steel magnetic drive biotech process pump for sterile processes

CP Pump Systems

Stainless Steel Magnetic Drive Biotech Process Pump for Sterile Processes



Our company

CP is a highly innovative Swiss company with a rich tradition. Since 1948 we have specialised in developing and manufacturing premium quality high-tech products and providing services for international customers with the most rigorous requirements.

We produce reliable and innovative centrifugal pumps for the chemical, pharmaceutical, petrochemical, biotechnology, food and beverage industries. CP is represented in over 70 countries through its network and offers first-class customer services. This proximity guarantees customers worldwide an efficient local service.

Reflecting our deep commitment to energy efficient products and services, we deliver environmentally friendly solutions that always go hand in hand with maximum safety and economy. As a pioneer in this area, we advise and assist customers with a wide range of needs – throughout the value chain.

CP operates a quality management system certified to ISO 9001:2015.

Energy efficiency in industry

Nowadays, industry is facing increasing demands to improve sustainability and energy efficiency. Pumps are considered to play a key role because they offer vast potential to save energy and costs. Already recognising this back in 1999, CP took action and has become a pioneer in energy-saving pumping systems.

In recent years, we have continuously enhanced the hydraulic performance of numerous pump systems, increasing their efficiency by up to 30 per cent. At the same time, we have steadily improved pump safety, a mission we have vigorously pursued ever since our company was established in 1948.

We are wholeheartedly committed to promoting sustainable manufacturing in industry around the world. Our customers benefit from a comprehensive range of solutions that reduce costs and CO₂ emissions over the long term. Cleaner pumps, cleaner planet: we firmly believe that sustainable research, thinking and action always pay off for everyone.

Stainless steel magnetic drive biotech process pump for sterile processes

The sealless MKP-Bio magnetic drive pump has been engineered especially for sterile fluid handling in the pharmaceutical, biotechnology and food industries. Designed to EHEDG recommendations, the hygienic equipment design criteria of the European Hygienic Engineering & Design Group, the MKP-Bio also complies fully with DIN EN 12462 and 3-A Sanitary Standards.

As the MKP-Bio has no shaft seal, microorganisms cannot penetrate into the pump interior. Torque is transmitted by an inverted magnetic drive coupling. With its special design, the MKP-Bio also does not require a plain bearing carrier. Optimum lubrication and cooling of the single, centrally located impeller bearing assembly with the pumped fluid gives the MKP-Bio excellent running characteristics.

The pump impeller rotates stably about a stationary axis on the gyroscopic principle, maintaining a perfect hydraulic balance. This minimises bearing loads, increasing the reliability of pump operation.

Compact in design, the MKP-Bio pump has no dead areas and its interior is constructed with just a few, robust components. For process validation, the impeller can be removed simply without the use of tools. Mounted vertically, the MKP-Bio is fully self-draining through the suction port without needing additional flush, drain or vent connections. The pump ports provided are suitable for CIP and SIP. Wetted parts have a surface finish of $Ra \leq 0.4$ or better, inner corners are rounded with a radius of R3, and the surfaces are inclined by at least 3°. All wetted materials are FDA certified.

MKP-Bio

Stainless Steel Magnetic Drive Biotech Process Pump

Technical data

Capacities (min./max.)	2 to 264 gpm
Heads (min./max.)	16 to 263 ft
Temperatures (min./max.)	- 4 to +302°F
Kinematic viscosities	0.5 to 350 cSt
Solids handling	after technical clarification

Directives

EC Machinery Directive
EC ATEX Directive
Hygiene standards 3-A
EHEDG
FDA 21 CFR §177
USP Class VI

Standards

DIN EN 12462
DIN EN ISO 5199
DIN EN ISO 15783

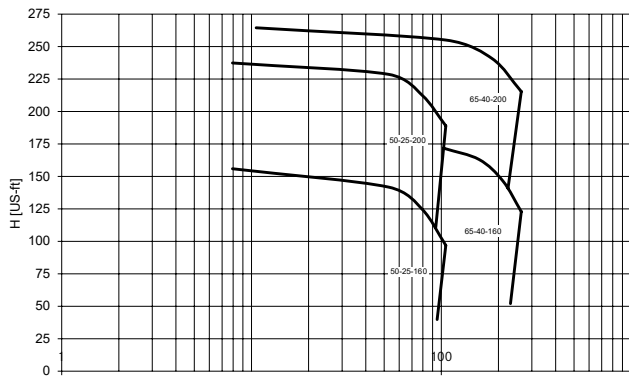

3600 rpm/60 Hz US

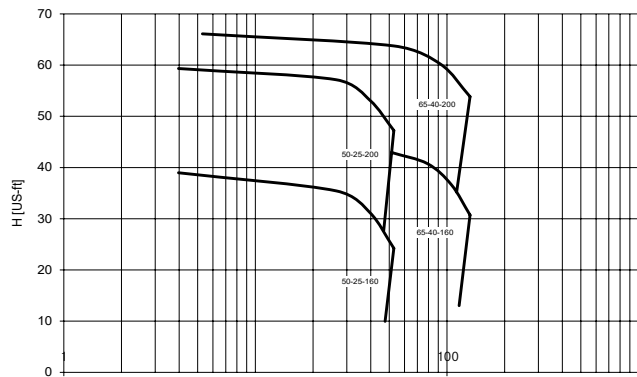

1800 rpm/60 Hz US

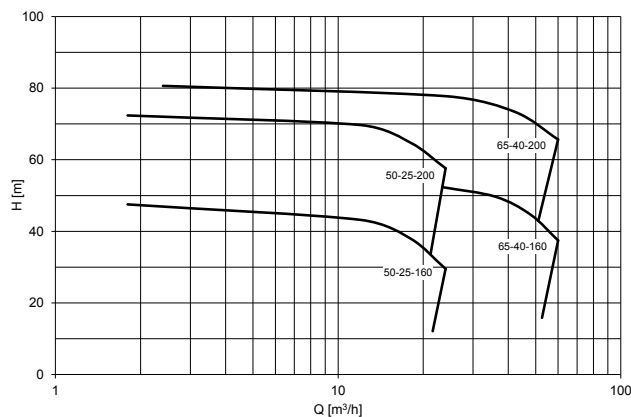

3600 rpm/60 Hz

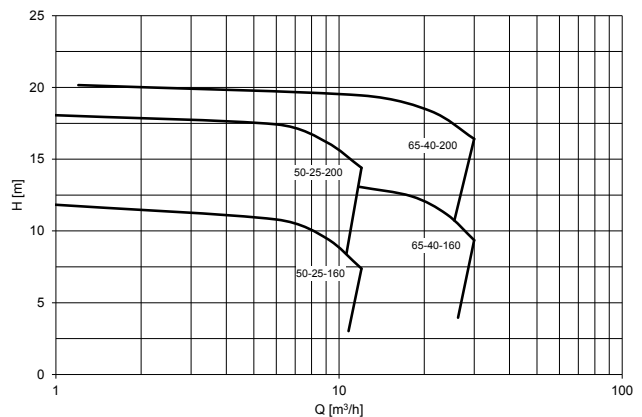

1800 rpm/60 Hz

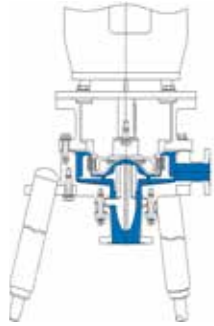

Close-coupled MKP-Bio
with tripod
-4 °F bis +302 °F



MKP-Bio with tripod and motor
vertical close-coupled (-4 to +302°F)

Options

Comprehensive – Individual – Combinable

Casing

Materials

- Stainless steel 1.4404/1.4435 (316)
- Stainless steel (e.g. 1.4306, Uranus® B6)
- Nickel-base alloys (e.g. Hastelloy® C-4, C-22)

Pressure rating

- PN 16

Connection flanges

- To DIN 11864
- To DIN 11866
- To EN 1092-1
- To NEUMO
- To BBS
- To ASME BPE (Tri-Clamp)

Additional connections

- Lantern monitoring connection

Gasket materials

- EPDM
- FEP/FKM
- Kalrez®



Bearing Assembly

- SSiC (sintered silicon carbide) with diamond-like coating (ADLC)
- Nickel-bound tungsten carbide with diamond-like coating (ADLC)
- Anti-friction bearings made of Si_3N_4 (silicon nitride) ceramic





Containment shell

Materials

- Hastelloy® C-4
- Hastelloy® C-22



Pump protection

Containment shell thermocouple

Engine load sensor



Mounts

Types

- Tripod with sprung, vibration-damping legs and ball feet
- Angle stand
- Vertical

Materials

- Stainless steel

Stilts



Sectional View

MKP-Bio

vertical close-coupled (-4 to +302°F)

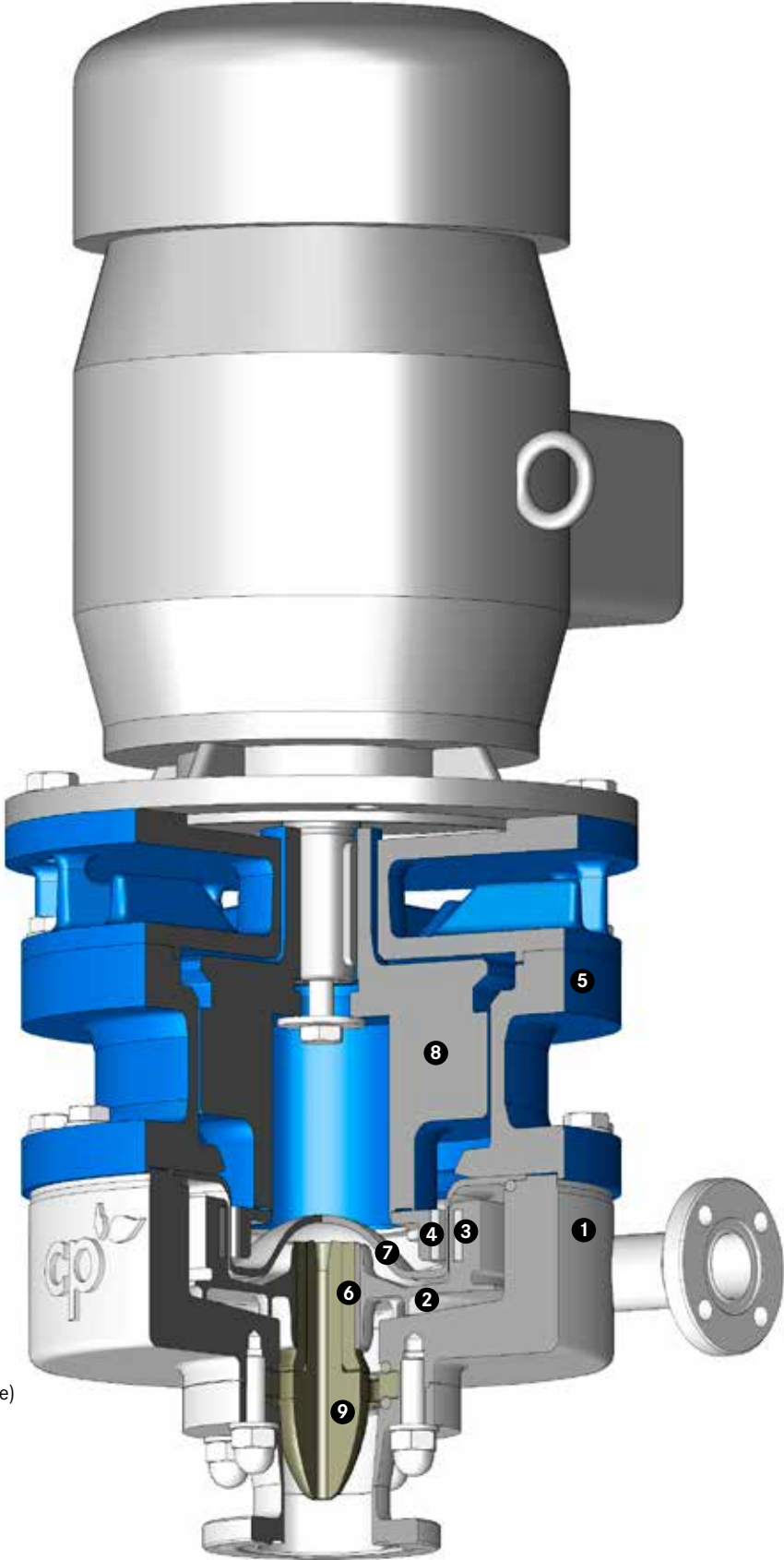

- 1 Pump casing
- 2 Impeller
- 3 Driven magnet assembly attached to impeller (on product side)
- 4 Drive magnet assembly (on atmospheric side)
- 5 Lantern
- 6 Plain bearing assembly
- 7 Hermetically sealed containment shell
- 8 Flywheel
- 9 Hub



MKP-Bio magnetic drive pump casing with tripod

Applications

Versatile – Complex – Special

CP's magnetic drive centrifugal pump for sterile processes is engineered to meet the most stringent quality standards and ensure reliability and utmost safety in production operations. Suitable for many different fluids in a variety of industries and processes, it is capable of handling low, medium and high flow volumes. The MKP-Bio magnetic drive pump from CP offers tremendous advantages, especially in pumping very sensitive substances.

Industries

- Chemical processing: basic and fine chemicals (agrochemicals, speciality chemicals)
- Pharmaceuticals
- Biotechnology processing

Processes

CP's magnetic drive centrifugal pump for sterile processes is designed for a wide range of processes, including:

- Aseptic carbonation
- Beverage filtration
- Cleaning cycles (CIP)
- Cold aseptic filling processes
- Sterile and/or hygienic processes (SIP)
- Textile washing, treatment and dyeing
- Thermal disinfection
- Yeast propagation

Fluids

CP's magnetic drive centrifugal pump for sterile processes can handle acids, bases, solvents and other sensitive fluids.

For example:

- 2-Propanol (IPA)
- Alcohols
- Aliphatic compounds
- CIP fluids
- Concentrated nutrient solutions
- Phenethylamines
- Sodium hydroxide solution
- Solvents
- Toluene

Our sales staff will be glad to give you personalised advice tailored to your specific needs, industry, processes and fluids.



Customer service

We offer the highest quality, many years of experience and first-class advice from a single source. Our bespoke pump systems meet a wide range of different requirements.

CP's customers benefit from a full service offering: the fastest availability of genuine spare parts, a complete set of technical documentation, competent and efficient customer support, and a dynamic and flexible repair service. All these services ensure that your pumps will operate faultlessly. Thanks to a network in over 70 countries, we advise and serve our customers directly on site.

Energy efficiency consulting

As a trend scout specialised in energy efficiency, CP can deliver a wide spectrum of services relating to pumps and motors: comprehensive advice, in-depth system analysis, meticulous planning and design. Our goal is to actively help our customers optimise the energy consumption of their pumping systems and thereby cut costs over the long term.

Backed by our many years of broad experience, we today advise and assist customers in both the private and public sectors. These include owners and operators of fluid processing plants in the chemical, pharmaceutical and diverse other industries.

Are you interested? Do you have any questions? We would be happy to discuss all the different options with you personally.

Stainless steel magnetic drive centrifugal pumps

MKP

Magnetic drive chemical process pump

MKP-S

Self-priming magnetic drive chemical process pump

MKTP

Magnetic drive chemical process sump pump

MKP-ANSI

Magnetic drive chemical process pump

MKPP

Magnetic drive in-line chemical process peripheral pump

SZMK

Magnetic drive in-line chemical process pump

Stainless steel magnetic drive biotech process pump

MKP-Bio

Magnetic drive centrifugal pump for sterile processes

PFA lined magnetic drive centrifugal pumps

MKPL

Magnetic drive chemical process pump

MKPL-S

Self-priming magnetic drive chemical process pump

Solid PTFE magnetic drive centrifugal pumps

MSKP

Magnetic drive chemical process pump

MSKPP

Magnetic drive chemical process peripheral pump

MSKS

Self-priming magnetic drive chemical process side channel pump

Stainless steel mechanical seal centrifugal pumps

ZMP

The 3-In-One mechanical seal chemical process pump: crushing, mixing and pumping

PFA lined double mechanical seal centrifugal pump

EB

Double mechanical seal chemical process pump

Ceramic lined double mechanical seal centrifugal pump

ET

Double mechanical seal chemical process pump

Improving Energy Efficiency in Pumping Systems Helps to Create a Cleaner Planet.

Headquarters

CP Pumpen AG
Switzerland, Zofingen



Distribution companies

CP Pumpen GmbH
Germany, Mannheim

CP Pompes SAS
France, Strasbourg

CP Pumps Inc.
USA, Birmingham (AL)

CP Pumps Thailand
Thailand, Bangkok

CP Pump Limited 씨피 펌프 유한회사
Republic of Korea, Seoul

Please find your local CP distributor on
www.cp-pumps.com.
or contact CP directly:
[+41 62 746 85 85 / info@cp-pumps.com](mailto:info@cp-pumps.com).

